

REVIEW

Titanium oxide antibacterial surfaces in biomedical devices

Livia Visai^{1,2}, Luigi De Nardo^{3,4}, Carlo Punta^{3,4}, Lucio Melone³, Alberto Cigada^{3,4}, Marcello Imbriani⁵, Carla Renata Arciola⁶

¹Department of Molecular Medicine and Center for Tissue Engineering (C.I.T), University of Pavia, Pavia - Italy

²Salvatore Maugeri Foundation IRCCS, Pavia - Italy; and International Center for Studies and Research in Biomedicine (ICB) - Luxembourg

³Department of Chemistry, Materials, and Chemical Engineering "Giulio Natta", Politecnico di Milano, Milan - Italy

⁴INSTM (National Consortium for Materials Science and Technology) Local Unit, Politecnico di Milano, Milan - Italy

⁵Department of Public Health and Neuroscience and Maugeri Foundation IRCCS, Pavia - Italy

⁶Research Unit on Implant Infections, Rizzoli Orthopaedic Institute and Department of Experimental Pathology of the University of Bologna, Bologna - Italy

ABSTRACT

Titanium oxide is a heterogeneous catalyst whose efficient photoinduced activity, related to some of its allotropic forms, paved the way for its widespread technological use. Here, we offer a comparative analysis of the use of titanium oxide as coating for materials in biomedical devices. First, we introduce the photoinduced catalytic mechanisms of TiO₂ and their action on biological environment and bacteria. Second, we overview the main physical and chemical technologies for structuring suitable TiO₂ coatings on biomedical devices. We then present the approaches for in vitro characterization of these surfaces. Finally, we discuss the main aspects of TiO₂ photoactivated antimicrobial activity on medical devices and limitations for these types of applications.

KEY WORDS: *Biomaterial surface modifications, Titanium oxide, Antibacterial properties, Infection-resistant materials*

Accepted: August 31, 2011

TITANIUM OXIDE AND ANTIBACTERIAL SURFACES IN BIOMEDICAL DEVICES

Device-related infections: a clinical demand driving material science research

An increasing number of clinical procedures requires the use of biomedical devices, whose widespread presence in modern therapeutic treatments is driving the demand for better performances and longer reliability. One of the major issues of both short-term devices and implantable prostheses is represented by device-related infections (DRIs)

due to bacterial colonization and proliferation (1). About half of the 2 million cases of nosocomial infections that occur each year in the United States are associated with indwelling devices (2); these infections generally require a longer period of antibiotic therapy and repeated surgical procedures, resulting in potential risks for the patient and increased costs for the healthcare system.

The planktonic bacteria that colonize a device surface tend to form a biofilm and the sessile bacterial cells, enclosed in a self-produced polymeric matrix of this kind, can withstand host immune responses and generally show extraordinary antibiotic resistance (3). Eventually, bacteria rapidly multiply and disperse in planktonic form, giving rise

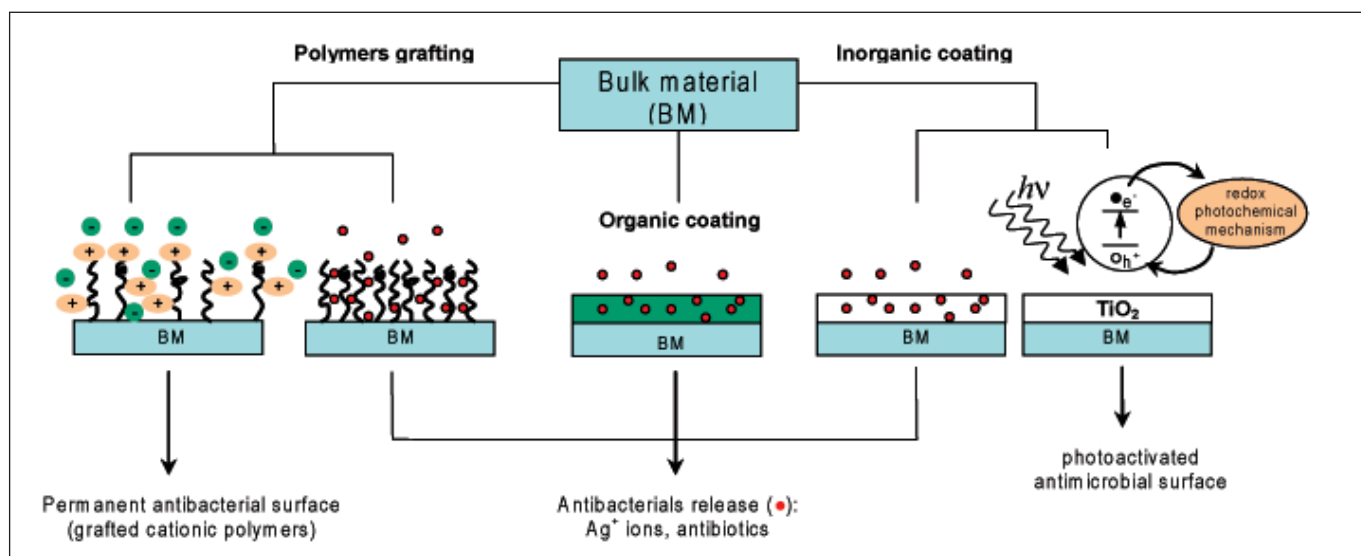

Fig. 1 - Surface modification approaches in medical devices aimed at obtaining antibacterial properties.

to a chronic infection that is not easy to eradicate by conventional antibiotic therapy. In some cases, there are no early signs of bacterial infections and their outbreaks are masked by the ongoing tissue inflammation due to the surgical procedure. Hence, DRI diagnosis often occurs when a full-blown infection has already damaged tissues of the host organism (1), thus making reoperation of infected implants mandatory.

Specific guideline practices have been designed with the aim of minimizing the risks of infection on biomedical devices (1-3). However, implantation procedures are increasingly performed in a population that comprises relatively older and more immunocompromised patients, with growing risks of morbidity and mortality. Although systemic therapies can be used in DRI treatment, these methods are potentially not effective due to impaired blood circulation and the need for a high concentration of antibiotics (4). A promising alternative to a conventional systemic therapy is represented by the design of device surface properties aimed at locally modulating interfacial interactions between implanted devices and host tissues. Bacterial colonization of medical devices leading to DRIs is, in fact, a surface-mediated process, one that poses challenging problems to biomaterial scientists.

The modulation of device properties via chemical composition and structure modification of the surface rep-

resents the focus of several ongoing research programs (5) aimed at improving current bulk biomaterials with a wide variety of chemical and physical patterns in order to control *in vivo* cell size, shape, spatial organization, and proliferation (6). It is important to note that for some applications the study of new surfaces is also a distinctive departure from "standard" products (7), which are mainly marketing-driven.

Several surface modification approaches aimed at introducing surface-assisted antibacterial properties have been described so far, and comprehensive and excellent reviews have been published (1, 4, 8-10): a scheme of the possible strategies for antibacterial surface coatings is shown in Figure 1.

There is a number of efforts addressed at designing surfaces that provide the release of an antibacterial agent: polymers and polymer coatings represent a potentially interesting approach when controlled drug release of organic molecules or inorganic antimicrobial compounds is envisaged (11-15). Drug release from a loaded matrix has intrinsic disadvantages involving the duration and effectiveness of the antibacterial action, since they are limited by loading and release kinetics (1). An alternative is represented by covalent immobilization of antibiotic molecules, which show the ability to prevent bacteria adhesion (16). A completely different approach is based on inorganic (or hybrid organic-inorganic) coatings, in

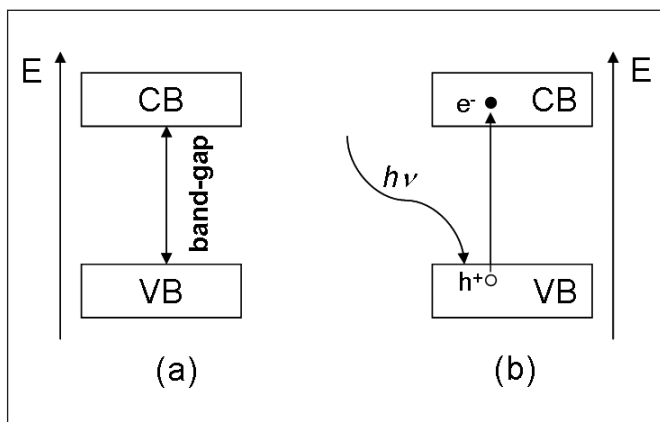

Fig. 2 - Band energetic structure (a) and mechanism of photo-irradiation (b) of a semiconductor.

which both an antimicrobial compound release and an intrinsic antibacterial activity are possible. In this review, we will focus our attention on the latter approach, based particularly on titanium oxide, whose antibacterial properties primarily relate to the semiconductor nature of this oxide.

Photocatalytic activity in titanium oxide surfaces

Photocatalytic activity in semiconductors

In the last three decades, photocatalytic processes promoted by semiconductors (SC) have found a widespread application in many fields, including water splitting, energy production, air and water purification, surface sterilization and organic synthesis (17-23). The reasons for this increasing interest in photocatalytic protocols are the growing demand for reducing environmental pollution and for developing more eco-friendly and cheaper processes. It is well known that a SC is characterized by a band energetic structure, with a band gap between the lower valence band (VB), entirely filled with electrons, and the unoccupied, higher energetic conduction band (CB) (Fig. 2a). When the SC is photo-irradiated by light with photon energy ($h\nu$) at least equal to the band gap, electrons present in the occupied band are photoexcited and move to the CB, leaving a positive charged hole in the VB (Fig. 2b) (24). Once formed, the electron and hole

pair (e^-h^+) may undergo either fast recombination, in a time range of picoseconds, or charge trapping, if in the presence of suitable e^- or h^+ scavengers (for example molecular oxygen and water, respectively). In the latter case, a photocatalytic reaction occurs, leading to the development of a wide range of useful processes.

Titanium dioxide (titania, TiO_2) is undoubtedly the most commonly employed of the n-type semiconductors, thanks to its high photoactivity and stability, relatively low cost, and non-toxicity. Often metal-doped in order to increase the λ radiation adsorption, it is the photocatalyst of choice in organic synthesis (25-29) for the preparation of smart-materials with self-cleaning and self-sterilizing surfaces, and for environmental purification (air and water) (24, 30-32).

TiO_2 exists in three main polymorphs: anatase, rutile, and brookite. Anatase shows a band gap of 3.2 eV, corresponding to a UV wavelength adsorption of 385 nm. In contrast, rutile has a smaller band gap (3.0 eV), with excitation wavelengths that extend into the visible light range (410 nm). Nevertheless, anatase is generally considered the most photochemically active phase of titania. The reason for this higher activity should be attributed to the combined effect of the higher surface adsorptive capacity of anatase and its higher rate of hole trapping. Recently, studies have shown that mixtures of anatase-rutile or brookite-anatase were more active than anatase alone (33, 34).

Photooxidations promoted by TiO_2 : the role of O_2 and H_2O

When TiO_2 -surfaces are irradiated with suitable photon energies under aerobic conditions, leading to the formation of the e^-h^+ pairs (Eq. 1), molecular oxygen can act as an electron scavenger, providing the corresponding superoxide radical (Eq. 2). This reaction, which competes with the fast electron-hole recombination, represents the initiation phase of a free-radical chain promoted by water (Eq. 3), leading to the formation of hydroxyl ($\bullet\text{OH}$) radicals (Eqs. 4 and 5, Scheme 1).

$\bullet\text{OH}$ radicals, which can also be generated via direct oxidation of water and adsorbed hydroxide ion (Eqs. 7 and 8, Scheme 2) by means of photo-generated holes (35, 36), were found to be present on irradiated TiO_2 surfaces by spin trapping experiments with EPR spectroscopy (32).

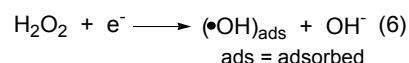
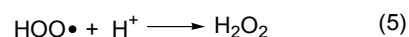
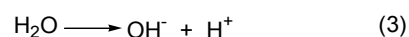
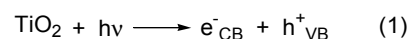

Scheme 1 - Mechanism of photoinduced formation of hydroxyl radical from O₂.



Scheme 2 - Mechanism of photoinduced formation of hydroxyl radical from water.

Once formed, these highly reactive radical species seem to play a key role in promoting the indirect oxidation of organic substances (Eqs. 9-11, Scheme 3).

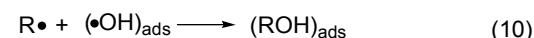
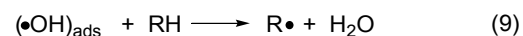

Scheme 3 - Indirect oxidation of organic substances promoted •OH radicals.

Nevertheless, more recently Fox (37, 38) and Tachikawa (39, 40) have demonstrated that in many cases the same products could also be formed via direct oxidation by holes (Eq. 12), partially reconsidering the over-estimated role of •OH radicals.

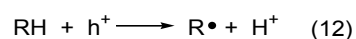

In this context, O₂ has not only the role of electron scavenger in the initiation phase (Eq. 2), it is also involved in further reactions with organic radical species, leading to products of partial or total oxidation (Eq. 13-15, Scheme 4) (41).

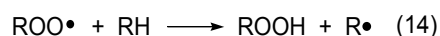

Scheme 4 - Formation of active oxygen-centered radicals by means of O₂.

The role of water in photocatalysis on TiO₂ is no less important. If the promotion of photooxidative processes appears clear from its capability to generate hydroxyl radicals on TiO₂-surfaces, its inhibition action by site blocking must be stressed as well (42). Site blocking may occur through two different routes, one according to which water occupies key adsorption and/or reaction sites on the surface, and the other one in which the access of reactants on the surface is inhibited by a solvent effect (24).

Mechanisms of self-disinfection activity on TiO₂

One of the main advantages of photocatalytic sterilizing surface is the fact that they operate without electrical power or chemical reagents, since light, oxygen and water are the only required ingredients. TiO₂ surfaces are not poisonous and do not cause environmental pollution. These characteristics make self-sterilizing TiO₂ materials the products of choice for future medical applications.

The antibacterial properties of irradiated TiO₂-surfaces derive from the combination of two different characteristics of these materials, namely, their self-cleaning and self-disinfection properties. Self-cleaning can be considered an indirect action against bacteria. In fact, degradation of organic substances (Eq. 16) by total oxidation (43), according to the mechanism previously disclosed, prevents from bacteria and biofilm adhesion on material surfaces.

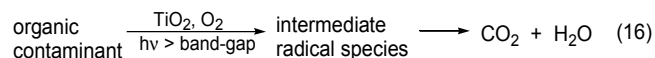

As far as the direct antibacterial activity by irradiated TiO₂-surfaces is concerned, the real mechanisms which regulate bacterial killing are still under debate.

Matsunaga et al (44, 45) explained the mechanism of sterilization by TiO₂ powders on *Escherichia coli* cells evaluating the concentrations of coenzyme A (CoA). It is known that CoA mediates an electron transfer between the cell and an electrode or a semiconductor. They showed that the de-

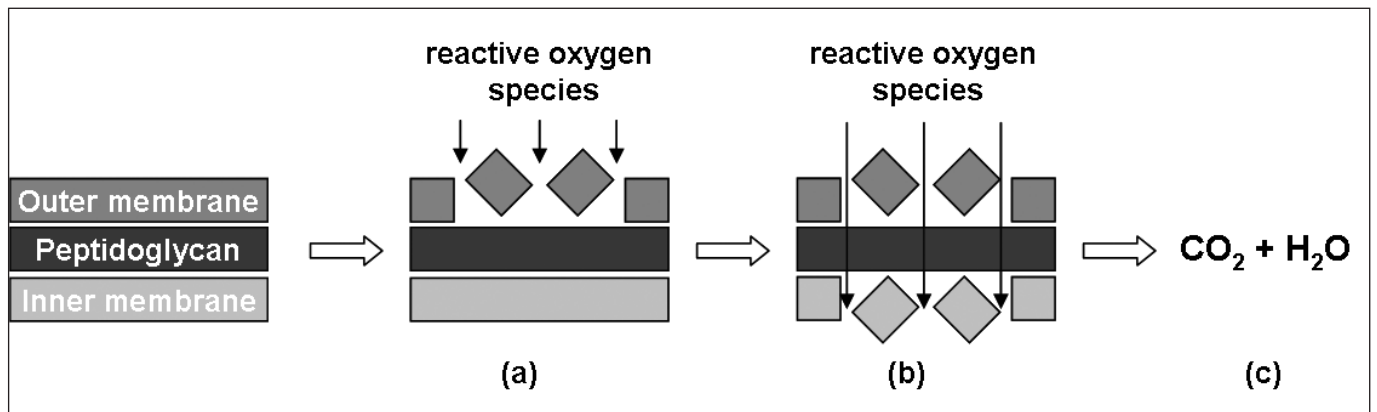

Fig. 3 - Three-step proposed mechanism for photokilling of bacteria on irradiated TiO₂-surfaces.

crease of CoA in the bacterial cells is related to the irradiation time and to the increase of the dimeric CoA concentration, causing inhibition of respiration. However, different types of experimental evidence have shown that the killing action of irradiated TiO₂ is primarily due to membrane and cell wall damage. In a recent review Dalrymple et al (46) have presented details of the kinetic aspects of the killing mechanism and explored the theoretical development of a model for photocatalytic disinfection based on lipid peroxidation.

In particular, Sunada et al (47) proposed a three-step mechanism for photokilling of bacteria on irradiated TiO₂-surfaces (Fig. 3): (a) attack of cell walls by reactive oxygen species; (b) disordering of the inner cytoplasmic membrane and killing of the cell; (c) decomposition of the toxic ingredients of bacteria.

In the first stage the outer membrane is partially damaged. This first attack does not particularly affect the vitality of the cell, but it changes the permeability of bacterium towards reactive species, which can enter the cell and attack the cytoplasmic membrane by lipid peroxidation (second step). It is at this stage that the structural and functional disordering of the inner membrane leads to cell death.

The third step is what makes photocatalytic sterilization the most effective technique when compared with classical antibacterial treatments. At longer reaction times, dead bacteria were found to be completely mineralized mainly to CO₂ and H₂O, once again due to the before-mentioned self-cleaning property of photo-irradiated TiO₂-surfaces (Eq. 16).

STRATEGIES TO OBTAIN TITANIUM OXIDE SURFACES ON MEDICAL DEVICES

Surface modification technologies for antibacterial properties in biomedical devices

The interest in titanium oxide as biomaterial surface is originally due to the performances of Ti and its alloys (Ti alloys, hereafter) commonly used in biomedical device manufacturing. Ti alloys are covered by a thin (nanometric) TiO₂ film, that spontaneously grows on their surfaces in air. This nanometric layer preserves the properties of the bulk material and interacts with biological fluids, resulting in a modulation of specific responses with the contact biological tissues (48). The comprehension of the role of TiO₂ film on biomedical Ti alloys paved the way to intense research activity focused on technologies for modifying and structuring the natural oxide layer in order to increase its resistance and give rise to novel properties (see, for instance, the results obtained in increasing the corrosion resistance of Ti alloys by increasing the oxide layer thickness in (49) (48, 50-52).

Industrial applications of photoactive materials, such as antifogging and self-cleaning surfaces, became popular in the last decade: however, their medical applications are still limited and seem to be still under development (4). To take advantages of the photo-activated processes of TiO₂ over the wide range of bulk biomaterials, several studies have been conducted in order to deposit thin and adherent

films, with specific crystallographic phases (i.e., anatase or rutile). It is generally accepted that crystalline phases (even in their nanostructured forms) possess photo-activated antimicrobial behavior. However, a study from Choi and co-workers showed that even the natural oxide layer covering commercially pure Ti possess antimicrobial behavior, with no significant differences among non-treated, anodic, and thermal-treated specimens (53). This finding could be explained by taking into account that in a native, essentially amorphous, titanium oxide film a certain degree of short-range order in the nanometer range is likely to occur (54). It becomes evident that a tuning of the surface properties of this oxide paves the way for the exploitation of structured-TiO₂ properties, by maintaining the bulk material properties of Ti alloys and, mainly, of materials other than Ti alloys. In the following section we offer an overview of the available surface technologies allowing the deposition and/or structuring of TiO₂ films with antibacterial properties. A particular emphasis is placed on the methods that can be easily scaled-up to large production of medical implants. For the sake of simplicity, we will classify these surface modifications according to the involved technologies.

Chemical and electrochemical methods

Sol-gel

Sol-gel is a wet chemical technology based on a sequence of synthesis steps similar to an organic polymerization for the synthesis of inorganic and organic-inorganic hybrid oxides (55). It is generally realized by means of hydrolysis and condensation of metallorganic alkoxide precursors, although inorganic precursor synthesis is also commonly used (55). Using this technique, bioactive silica-based thin films for biomedical applications have been produced (56-58). By using suitable Ti precursors, thin TiO₂ coatings, based on either conventional (59) or the Stepwise Surface process (60), can be obtained on different substrates. Surface modifications aimed at obtaining antibacterial properties using sol gel TiO₂ coatings have been realized by several research groups (12, 61-71), even if in some cases it is difficult to compare the results due to scarce homogeneity in surface preparation, chemico-physical characterization, and the selected bacteria strains and methods (this point will be further elucidated in the next section). Chun et al (64) proposed the modification of orthodontic

wires made of stainless steel as bulk material and tested its photo-activated antiadherent properties (on *Streptococcus mutans*, which are the cause of dental caries) and its antibacterial properties (on *S. mutans* and *Porphyromonas gingivalis*, the former causing periodontitis) of these surfaces. They found that the bacterial mass that bound to the TiO₂-coated orthodontic wires remained unchanged after adhesion tests, whereas uncoated wires increased their mass by 4.97%. Furthermore, the TiO₂-coated orthodontic wires had a bactericidal effect on both strains; since one of the main causes of failure in orthodontic treatment is the development of dental plaque initiated by the adhesion of *S. mutans* to the tooth surface or orthodontic devices, this treatment appears of particular interest for this specific device (64).

This example allows us to point out that materials other than Ti alloys can be treated in order to add a thin titanium oxide layer onto their surface: results of this sort have been achieved by other authors on different organic and inorganic substrates (4, 70-73). Another advantage of using the sol-gel technique is the possibility of incorporating metal ions, nanometric clusters, and bactericidal molecules that in most cases have antibacterial properties *per se*, namely Ag ions/nanoparticles (61, 63, 74-76), or Cu ions (69, 73). The presence of these dopants on TiO₂ structure plays a synergistic role in photokilling bacteria, since they can act as: (i) *antimicrobial species*, when directly released in concentration enough to directly kill the bacteria species; (ii) *charge separator enhancers*, enhancing the efficiency of the redox reactions; (iii) *oxidants* (e.g., Cu²⁺ has been demonstrated to reduce to Cu⁺ and react with H₂O₂ in a Fenton-Type reaction, resulting in the production of •OH radicals). Obviously, these synergistic effects, deriving from doping TiO₂ structures are not peculiar of sol-gel technology, and have hence been explored also using other technologies, as discussed below.

Several examples other than those reported here can be found in literature (4, 61, 63, 69-77), and we suggest the reader refer to each of these works to have an overall idea about ongoing research studies. However, some general conclusions on this technique can be drawn. Sol-gel allows the treatment of different bulk materials, without affecting the morphology at the micrometric scale. Different allotropic forms can be deposited and their tuning depends on the chemical-physical steps involved in the preparation of sol and following film deposition and curing. Moreover, it is quite an economic solution, providing that surfaces are

correctly prepared and devices have a simple 3D shape (sol-gel coatings can be deposited mainly either *via* dip or spray coating).

As a general suggestion to the reader, this technique appears particularly useful in producing advanced antibacterial coatings: due to the simple industrial scale-up and the esthetic quality of the resulting film, it represents a powerful tool in medical device design that has yet to be fully exploited.

Electrochemical technologies

Electrochemical surface modifications are based on electric polarization of electrical conductive substrates in three different modes: anodic oxidation, cathodic polarization (or Electrolytic Deposition (ELD)), and electrophoretic deposition (EPD). Cathodic polarization is generally used for the deposition of calcium phosphate coatings and for this reason will not be further discussed in this review.

Anodic oxidation

Anodic polarization allows thick and conveniently structured Ti oxide films to be achieved only over the surface of Ti alloys: electrode reactions in combination with electrical field-driven metal and oxygen ion diffusion lead to the formation of an oxide film at the anodic surface (48, 78). (The explanation for the electrochemical processes involved in anodization can be found in several works (48-50, 79-84).) The anodic oxide film growth is a two-stage process that results in either a thin or thick titanium oxide film: up to 160 V of applied voltage drop in the electrochemical cell, a linear growth in the nanometric range of the TiO₂ film is achieved (50); when anodization is carried out at higher voltages, an increased gas evolution and often sparking are obtained, resulting in titanium oxide films up to tenth μm thickness. The latter process is generally called Micro-arc oxidation (MAO) or Anodic Spark deposition (ASD) (48, 78).

Morphological and structural features of oxides can be hence tuned using anodization over a wide range, resulting in films of increased oxide thickness, porous coatings, and selected crystallographic forms. Moreover, ion insertion in TiO₂ structure is also possible, providing that a suitable electrochemical bath is selected, although TiO₂ ion doping at low voltage anodization is actually a controversial issue (80, 81, 85, 86). Diffraction studies showed the oxide films

to be either totally amorphous or in some cases partially crystalline (82).

The presence of the anatase phase has been shown to play an important role in the reduction of bacterial colonization on low-voltage anodized surfaces (87). Del Curto et al proposed an anodization followed by a heat treatment to induce phase conversion of the TiO₂ layer; the resulting surfaces exhibited a remarkable reduction in the attachment of three streptococcal strains.

When anodization is carried out at higher voltages local melting and re-crystallization processes result in the incorporation of ionic species with a concentration gradient along the oxide: the electrolytic bath affects the final chemical composition of the grown oxide. An interesting treatment has been proposed by Song et al (88): they obtained Ag- or Pt-containing coatings on Ti-based implants by performing MAO in a bath composed of silver and platinum salts. Antibacterial properties were evaluated by using *S. aureus* and *E. coli*. Lower Ag-containing coatings exhibited *in vitro* antibacterial activity with no cytotoxicity, while higher Ag concentrations had a cytotoxic effect.

These two examples allow us to draw some main conclusions: the anodization process can be effectively applied for titanium modification and coating preparation for biomedical applications, taking advantage of both the morphological and chemical results of such treatments, since these films show controlled porosity, morphology, chemical composition, and allotropic structure (50, 89-92). Anodic modification technology thus appears interesting when complex devices made of Ti alloys need to be treated in order to obtain antibacterial properties.

Electrophoretic deposition

Electrophoretic deposition allows the deposition of coating from almost any material class, including metals, polymers, and ceramics (93-96). The mechanism of electrophoretic deposition involves electrophoresis, in which charged particles move toward an electrode of opposite charge, and deposition, due to the motion of charged particles and their local accumulation. Coating formation is achieved via particle coagulation (93-96).

EPD appears of particular interest in surface modifications of materials for biomedical application (48, 78) because the deposition of either inorganic or hybrid coatings with high purity is possible on complex geometries. Promising results have also been obtained in TiO₂ antibacterial

coatings: Santillán et al (97) studied the synthesis of TiO₂-Ag composite nanoparticles and the fabrication of TiO₂ and TiO₂-Ag coatings on titanium substrates by EPD. Ag nanoparticles (_{NP}Ag) were directly formed and grown on the surface of TiO₂ nanoparticles (_{NP}TiO₂) from nucleophilic reaction catalyzed by alkalis. They were able to demonstrate the feasibility of EPD of TiO₂-Ag coatings on titanium substrate and that all the developed coatings showed *in vitro* bioactivity, with a degree of bioactivity qualitatively decreasing as Ag content in TiO₂ coatings increased. However, the authors did not evaluate the bacterial response of these coatings.

Chemical Vapour Depositions (CVD)

The growth of TiO₂ films can also be pursued by using an RF plasma enhanced chemical vapor deposition method (PECVD), which is a variant of the chemical vapor deposition (CVD). This technique allows the deposition of thin films of different materials (for example silicon dioxide or silicon nitride) starting from their precursors and operating at lower temperatures due to the plasma action that facilitates the occurrence of the chemical reactions. For example, with regard to the titanium dioxide, Szymanowski et al (98) reported the deposition of TiO₂ onto glass slides and Rashig rings in order to create TiO₂ film having photo-induced antibacterial properties. They used titanium tetrachloride diluted in argon as source of Ti and gaseous O₂ as source of oxygen. The gaseous mixture was injected in a vacuum chamber (79.8 Pa) and irradiated with a RF power of 20 W to 300 W for 30 minutes. The TiO₂ film thickness grew up to more than 500 nm depending on the deposition power. The antibacterial capability was tested with *E. coli* strains (DH5α) showing good bacterial inhibition while increasing the TiO₂ film thickness. Other techniques frequently used are based on magnetron sputtering (99-101), ion beam sputtering (102) and spray pyrolysis (103).

Physical methods

Plasma Immersion Ion Implantation

One of the most widely used physical techniques for the generation of TiO₂ thin film on the surface of a large class of biomedical items is based on the immersion of the

material to be treated in a *plasma* under a high voltage bias (104-106). The term *plasma* is used to define a state of matter (“the fourth state of matter”) characterized by the presence of a significant number of electrically charged or ionized atoms and/or molecules having the fundamental characteristic of exhibiting a collective behavior due to long-range Coulomb interactions (107). The surface of the materials treated with the plasma can be modified by implanting new ionic species into the original materials. In this way a thin layer of the material surface is doped, allowing modification of mechanical, chemical and/or electrical properties. This process is generally called Plasma Immersion Ion Implantation (PIII or PI³). When a deposition of matter is performed by forming a thin layer of material, the process is called Plasma Immersion Ion Implantation and Deposition (PIII&D or PI³&D). The plasma techniques have a wide field of application, such as wear and corrosion protection, microelectronics, and medical-device manufacturing (108).

A number of authors have achieved the coating of different materials like metals, glasses, silicon wafers, and ceramics with TiO₂ with PIII&D techniques. Baba and Hatada (109) reported the deposition of a TiO₂ thin film onto fused quartz glass and silicon wafer through PIII&D using titanium tetraisopropoxide as precursor. The plasma was generated by a 50 W antenna irradiating RF power at 13.56 MHz at 1.3 Pa pressure. Negative pulses of 20 kV having a duration of 50 μs and a repetition rate of 100 Hz gave TiO₂ films with a thickness of 318 nm after annealing at temperatures between 673 K and 1023 K for 1 h. Similar results were obtained by Jing et al (110).

Shiraishi et al (111) described the preparation of antibacterial metal implant (titanium and SUS316 stainless steel) with a TiO₂ using a plasma source ion implantation followed by annealing. The TiO₂ layer conferred photocatalytic bactericidal effect against *S. aureus* under UVA irradiation.

The bactericidal effects of TiO₂ under UV-light irradiation is particularly useful for sterilizing the contaminated surface of dental implants as reported by Suketa et al (112). The authors used a plasma source ion implantation to deposit a layer of TiO₂ onto metallic titanium and tested the photobactericidal effectiveness of the resulting surfaces on *Actinobacillus actinomycetemcomitans* and *Fusobacterium nucleatum*, two microorganisms responsible for infections of the oral cavity.

Plasma spray

Plasma spraying is a different and also widely used technique to form ceramic and oxide coatings on a wide class of inorganic substrates. The process is based on the action of an electric arc that melts and sprays materials onto a solid surface. Generally the material to be deposited is injected in powder form using an inert gas (argon) as carrier. Both nanometric and micrometric powders can be used in order to obtain a different surface roughness (113). This technique presents several advantages, such as high deposition rates (80 g/min), thick deposits (hundreds of micrometers to several millimeters), and low costs. Moreover, the resulting coatings have a surface morphology characterized by a good degree of roughness that is particularly suitable in the orthopedic applications of titanium because it favors osteoblast adhesion (114).

Mixtures of TiO_2 and other oxides, like as Al_2O_3 , can also be deposited on stainless steel surfaces by atmospheric plasma spraying technique as described in (115). Often the TiO_2 powders are mixed with silver powders in order to have antibacterial activity even without light irradiation (116). The biocompatibility and the antibacterial activity of the TiO_2 coating onto titanium slides can also be improved by grafting collagen and eventually loading it with *gentamicin*, an aminoglycoside antibiotic (117).

IN VITRO EVALUATION OF TiO_2 ANTIBACTERIAL ACTIVITY

Since the demonstration of its antimicrobial activity, UV-activated TiO_2 has been used in suspension, in liquids, or immobilized on surfaces for the destruction of Gram-negative and Gram-positive bacteria, including endospores, fungi, algae, protozoa, viruses as well as for the inactivation of microbial toxins and prions (45, 72, 118-127). Ions such as Cu^{2+} and Ag^+ in combination with TiO_2 were reported to enhance its antimicrobial activity (72). Furthermore, the photocatalytic activity of TiO_2 was reported as performed against pure bacterial cultures, mixed cultures (128) and natural communities (129-131).

As a general concept, photocatalytic surfaces or suspensions are referred to as being self-disinfecting rather than self-sterilizing. Photocatalysis has been shown to be capable of killing more Gram-negative than Gram-positive bacteria as reported in an excellent mini-review by Howard

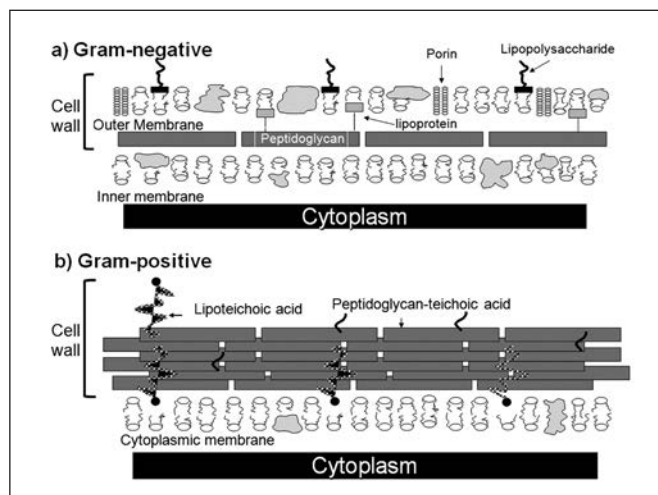

Fig. 4 - Outer layers of bacteria: (a) Gram-negative (b) Gram-positive.

et al (72). The difference is usually ascribed to the difference in cell wall structure and peptidoglycan thickness between Gram-positive and Gram-negative bacteria. The cell wall in Gram-positive bacteria is essentially composed of a very thick peptidoglycan layer whereas in Gram-negative bacteria it has a thin inner peptidoglycan layer externally surrounded by an outer membrane mainly enriched of lipopolysaccharide (LPS) and lipoprotein (Fig. 4).

Peptidoglycan is a peptide-crosslinked polysaccharide which surrounds bacterial cells and confers rigidity to maintain shape and internal pressure: in Gram-positive bacteria it accounts for as much as 90% of the cell wall whereas in Gram-negative bacteria it accounts for only 10%. But in Gram-negative bacteria, the outer membrane is the first external line of defense whereas in Gram-positive bacteria it is the thick peptidoglycan layer. However, it is not clear if the peptidoglycan layer is the critical target of attack by radicals or simply retards the diffusion of oxidants to the underlying vital sites (phospholipid bilayers) of bacterial cells.

Up to now, most studies have been performed against *E. coli* strains, but other Gram-negative bacteria have also been reported to be susceptible to TiO_2 photocatalytic activity. Regarding Gram-positive bacteria, species of 17 different genera, including aerobic and anaerobic endospore formers, were shown to be killed by TiO_2 photocatalytic activity (details in ref. (72)). Furthermore, the planctonic cells were less resistant to photocatalytic disinfection than endospores. The killing mechanism of photoactivated TiO_2

has been studied in Gram-positive and Gram-negative bacteria.

In vitro evaluation techniques to assess antibacterial properties

Different type of methods can be used to assess killing of microorganisms by photocatalysis such as *i*) evaluation of bacterial survivability, *ii*) determination of intercellular components leakage (cations, RNA and protein), *iii*) microscopy observations, up to *iv*) determination of lipid peroxidation products by spectroscopic studies and *v*) evaluation of killing of bacterial cells throughout biofilm.

Evaluation of bacterial survivability

Adhesions and proliferation assays are the first methods to perform for evaluating the killing efficacy of titanium oxide surfaces or suspensions. Cell survival can be expressed as the ratio of the Colony Forming Units (CFU) from bacteria treated with irradiated TiO₂ surfaces/suspensions and CFU from untreated bacteria (87, 92). Furthermore, a test with 3-(4,5-dimethylthiazole-2-yl)-2,5-diphenyl tetrazolium bromide (MTT) can be performed at different times of incubation to evaluate the mitochondrial activity of the bacterial cells. The former method is the most reliable it is time consuming whereas the latter is more rapid.

Evaluation of changes in membrane permeability

The leakage of intercellular components can be an indirect method for the assessment of bacterial membrane damage. Various studies performed on *Streptococcus sobrinus*, *E. coli* and *S. aureus* with TiO₂ showed leakage of potassium ions from the bacteria and the parallel decrease in cell viability (70, 72, 132-135).

Microscopy observations

Transmission Electron Microscopy (TEM), Scanning Electron Microscopy (SEM) and Atomic Force Microscopy (AFM) images of TiO₂-treated bacterial cells such as *S. mutans* (132), *Pseudomonas aeruginosa* (136), *E. coli* (47, 137-142), *S. aureus* (143), MRSA and methicillin-sensitive *S. aureus* (137), and *Streptococcus pneumoniae* (143) were used to show membrane damage and progressive destructions of cells if compared to untreated cells (72).

In general, microscopic studies showed morphological changes suggestive of cell wall disruption of UVA irradiated TiO₂ surfaces/suspensions. On *E. coli* cells, various degrees of cell disruption including plasmolysis, intracellular vacuoles ghost and cell debris was observed; in particular, the outer membrane is the first to be attacked, followed by the complete degradation of the cytoplasmic membrane. On *S. aureus* treated cells, a separation of cytoplasmic membrane from the peptidoglycan layer or cell distortion was observed. Photocatalytic killing for Gram-negative and Gram-positive bacteria occurred without substantial visible degradation of peptidoglycan.

Confocal Laser Scanning Microscopy (CLSM) can be effectively performed to show cell membrane damage using LIVE-DEAD® BacLight™ Bacterial Viability Kit. The kit includes two fluorescent nucleic acid stains: SYTO9 that penetrates both viable and nonviable bacteria, and propidium iodide that penetrates bacteria with damaged membranes and quenches SYTO9 fluorescence. Dead cells, which take up propidium iodide, fluoresce red, and cells fluorescing green are deemed viable.

Spectroscopic studies

X-ray diffraction (144), laser kinetic spectroscopy and attenuated total reflection Fourier Transform Infrared Spectroscopy (FTIR) (134, 145-147) were used to show cell disruption due to lipid peroxidation or direct oxidation. Lipid peroxidation occurs when polyunsaturated fatty acids (linoleic acid) are attacked by ROS such as hydroxyl radicals and H₂O₂ produced by irradiated TiO₂ surfaces. Malondialdehyde (MDA) is released as a product of membrane degradation. It has been suggested that the free radicals •OH and H₂O₂ were responsible for killing close to the TiO₂, with H₂O₂ acting at a distance (118, 148-152). Direct oxidation of bacterial components is feasible when cells are in direct contact with the surface of TiO₂. The oxidation occurs directly on the membrane components without production of reactive oxygen species as intermediates.

Evaluation of killing of bacterial cells throughout biofilm

Bacterial biofilms are associated with various pathological conditions in humans such as cystic fibrosis (*P. aeruginosa*), colonization of indwelling devices (*S. aureus* and *Staphylococcus epidermidis*) and dental plaque (oral streptococ-

cal strains) formation involved in caries and periodontitis. The possibility of evaluating the role of TiO₂ in the reduction of biofilm formation is becoming extremely important. A biofilm is defined as a microbial-derived sessile community and is characterized by cells that are embedded within an amorphous slimy material comprising mainly the polysaccharides and/or proteins secreted by the bacteria (153). For biofilm assays, bacterial cell cultures are statically incubated with the TiO₂ surfaces/suspensions overnight at 37°C. At the end of incubation, the cells are fixed and stained with crystal violet and then air dried. For a quantitative estimation of biofilms, the absorbance of the solubilized crystal violet is determined at 590 nm in a microplate reader (154). Recently, a TiO₂ catalyst was used for killing *S. epidermidis* cells throughout its biofilm (155). On the other hand, the photocatalytic activity was reduced by *P. aeruginosa* biofilm (156) and by a natural biofilm (157). The type of catalysts used and the different chemical composition of the bacterial biofilms can explain these differences. Furthermore, nanoporous TiO₂ was shown to not cause greater biofilm formation by oral commensal bacteria compared to other tested surfaces (90).

As mentioned above, different standard methods for testing antimicrobial efficiency of photocatalytic processes are available. Unfortunately, it is very difficult to compare results from different research groups, mainly because different bacterial strains have been used with different growth media and experimental conditions (128). A rigorous and scientific approach would be very helpful in order to produce comparable results and evaluate the real efficacy of photocatalysts in killing bacteria cells.

CONCLUSIONS

Antibacterial surface functionalization represents the most effective way to reduce DRIs. Despite huge efforts on the part of health care systems, prophylactic measures have succeeded mainly in reducing the frequency of early-stage infections, with minor results in late-stage processes of bacteria surface colonization (1). Several surface-mediated antibacterial approaches have been proposed, however, none of them have received widespread acceptance in clinics.

In this short review, we described one of these, namely, photo-induced bactericidal activity in TiO₂, and related technologies aimed at obtaining TiO₂ coatings on biomed-

ical devices. The reasons for a widespread interest in photocatalytic antibacterial activity are evident and supported by several research and literature articles (72). In particular, TiO₂ represents an ideal candidate as a photocatalyst (43): it is easy to produce and use, it is efficient in catalyzing reactions and has a wide spectrum of antimicrobial activity, since it is capable of killing a wide range of organisms including bacteria and endospores (72). Moreover, its biocompatibility is clinically proven, since a huge number of medical devices are made of Ti alloys (48, 158-162).

Both chemical and physical methods can be exploited in order to design and realize efficient photocatalytic surfaces, since materials science and technology now offer several ways to obtain TiO₂ surface coatings with suitable structures. Chemical approaches are, in our opinion, the most powerful, due to the possibility of coupling TiO₂ surfaces with organic molecules. However, the surface technology should be selected according to the device function and bulk material, providing that the process is compatible with the preservation of the overall device functionality.

There are some major limitations in TiO₂ coating applications used in biomedical devices as antibacterial coating. A main point that has been stressed in the previous section is that the coating should be designed for specific applications, taking into account the bacteria involved, their attachment and growth mechanisms, and the biological environment envisaged for the application. Unfortunately, testing of antibacterial coating efficacy is conducted in simplified environments *in vitro*; moreover, there are no common procedures, and clinical studies are costly and complex.

A second limitation in using TiO₂ coating applications as an antibacterial surface regards the activation mechanism: photons with enough energy have to reach the semiconductor surface in order to activate it and promote the catalytic processes. The problem of activating energy can be solved by doping TiO₂: the development of photocatalysts exhibiting high reactivity under visible light ($\lambda > 400$ nm) is actively promoted and structures can be prepared by metal-ion addition/implantation, reducing of TiO₂, or nonmetal doping (163). In the case of metal ion doping, a synergistic antibacterial effect can be achieved via the local release of antibacterial ions.

Despite some limitations, therefore, TiO₂ surface coatings appear to be a promising, powerful approach in the fight against transmission of infectious diseases.

Financial Support: Luigi De Nardo, C. Punta, and L. Melone acknowledge (i) INSTM – National Institute for Materials Science and Technology for financial support; (ii) MIUR - FIRB Futuro in ricerca (Surface-associated selective transfection - SAST, RBFR08XH0H) for a grant. L. De Nardo and A. Cigada also acknowledge Politecnico di Milano (Grant: 5 per Mille Junior) and the Italian Institute of Technology (IIT) for economic support.

Conflict of Interest Statement: Authors certify that there is no conflict of interest with any financial organization regarding the material discussed in the manuscript.

Address for correspondence:

Luigi De Nardo
Politecnico di Milano
Department of Chemistry, Materials and
Chemical Engineering “G. Natta”
Piazza L. da Vinci, 32
20133 Milano, Italy
e-mail: luigi.denardo@polimi.it

REFERENCES

1. Vasilev K, Cook J, Griesser HJ. Antibacterial surfaces for biomedical devices. *Expert Rev Med Devices*. 2009;6(5):553-567. doi:10.1586/erd.09.36.
2. Darouiche RO. Treatment of Infections Associated with Surgical Implants. *N Engl J Med*. 2004;350(14):1422-1429. doi:10.1056/NEJMra035415.
3. Costerton JW, Stewart PS, Greenberg EP. Bacterial Biofilms: A Common Cause of Persistent Infections. *Science*. 1999;284(5418):1318-1322. doi:10.1126/science.284.5418.1318.
4. Simchi A, Tamjid E, Pishbin F, Boccaccini AR. Recent progress in inorganic and composite coatings with bactericidal capability for orthopaedic applications. *Nanomedicine*. 2011;7(1):22-39. doi:10.1016/j.nano.2010.10.005.
5. Williams DF. On the nature of biomaterials. *Biomaterials*. 2009;30(30):5897-5909. doi:10.1016/j.biomaterials.2009.07.027.
6. Altomare L, Farè S. Cells response to topographic and chemical micropatterns. *J Appl Biomater Biomech*. 2008;6(3):132-143.
7. Vörös J, Wieland M, Laurence R-T, Textor M, Brunette DM. Characterization of Titanium Surfaces. In: Brunette DM, Tengvall P, Textor M, Thomsen P, eds. *Titanium in medicine: material science, surface science, engineering, biological responses, and medical applications*. Berlin, New York: Springer; 2001:87-144.
8. Zhao L, Chu PK, Zhang Y, Wu Z. Antibacterial coatings on titanium implants. *J Biomed Mater Res B Appl Biomater*. 2009;91(1):470-480. PubMed
9. Qiu Y, Zhang N, An YH, Wen X. Biomaterial strategies to reduce implant-associated infections. *Int J Artif Organs*. 2007;30(9):828-841.
10. Bruellhoff K, Fiedler J, Möller M, Groll J, Brenner RE. Surface coating strategies to prevent biofilm formation on implant surfaces. *Int J Artif Organs*. 2010;33(9):646-653.
11. Hetrick EM, Schoenfisch MH. Reducing implant-related infections: active release strategies. *Chem Soc Rev*. 2006;35(9):780-789. doi:10.1039/b515219b.
12. Catauro M, Verardi D, Melisi D, Belotti F, Mustarelli P. Novel sol-gel organic-inorganic hybrid materials for drug delivery. *J Appl Biomater Biomech*. 2010;8(1):42-51.
13. Kulkarni RV, Biswanath S. Electrically responsive smart hydrogels in drug delivery: A review. *J Appl Biomater Biomech*. 2007;5(3):125-139.
14. Gagliardi M, Silvestri D, Cristallini C, Guadagni M, Crifaci G, Giusti P. Combined drug release from biodegradable bi-layer coating for endovascular stents. *J Appl Biomater Biomech Res B Appl Biomater*. 2010;93(2):375-385.
15. Tanzi MC, Bozzini S, Candiani G, et al. Trends in biomedical engineering: focus on Smart Bio-Materials and Drug Delivery. *J Appl Biomater Biomech*. 2011;9(2):87-97. doi:10.5301/JABB.2011.8563.
16. Kenawy E-R, Worley SD, Broughton R. The Chemistry and Applications of Antimicrobial Polymers: A State-of-the-Art Review. *Biomacromolecules*. 2007;8(5):1359-1384. doi:10.1021/bm061150q.
17. Abe R. Recent progress on photocatalytic and photoelectrochemical water splitting under visible light irradiation. *J Photochem Photobiol C*. 2010;11(4):179-209. doi:10.1016/j.jphotochemrev.2011.02.003.
18. Kalyanasundaram K, Graetzel M. Artificial photosynthesis: biomimetic approaches to solar energy conversion and storage. *Curr Opin Biotechnol*. 2010;21(3):298-310. doi:10.1016/j.copbio.2010.03.021.
19. Malato S, Blanco J, Alarcón DC, Maldonado MI, Fernández-Ibáñez P, Gernjak W. Photocatalytic decontamination and disinfection of water with solar collectors. *Catal Today*. 2007;122(1-2):137-149. doi:10.1016/j.cattod.2007.01.034.
20. Ravelli D, Dondi D, Fagnoni M, Albin A. Photocatalysis. A multi-faceted concept for green chemistry. *Chem Soc Rev*. 2009;38(7):1999-2011. doi:10.1039/b714786b.
21. Gambarotti C, Melone L, Punta C. Semiconductors in organic photosynthesis. In: Najafpour M, eds. *Photosynthesis - Book 3*. InTech Open Access Publisher; (in press).
22. Palmisano G, Augugliaro V, Pagliaro M, Palmisano L. Photocatalysis: a promising route for 21st century organic chemistry. *Chem Commun*. 2007;33(33):3425-3437. doi:10.1039/b700395c.
23. Narayanam JMR, Stephenson CRJ. Visible light photoredox catalysis: applications in organic synthesis. *Chem Soc Rev*. 2010;40(1):102-113. doi:10.1039/b913880n.
24. Henderson MA. A surface science perspective on TiO₂ photocatalysis. *Surf Sci Rep*. 2011;66(6-7):185-297. doi:10.1016/j.surfrep.2011.01.001.

25. Caronna T, Gambarotti C, Palmisano L, Punta C, Pierini M, Recupero F. Sunlight-induced functionalisation reactions of heteroaromatic bases with aldehydes in the presence of TiO_2 : A hypothesis on the mechanism. *J Photochem Photobiol A*. 2007;189(2-3):322-328. doi:10.1016/j.jphotochem.2007.02.022.
26. Caronna T, Gambarotti C, Palmisano L, Punta C, Recupero F. Sunlight-induced reactions of some heterocyclic bases with ethers in the presence of TiO_2 : A green route for the synthesis of heterocyclic aldehydes. *J Photochem Photobiol A*. 2005;171(3):237-242. doi:10.1016/j.jphotochem.2004.10.017.
27. Caronna T, Gambarotti C, Palmisano L, Punta C, Recupero F. Sunlight induced functionalisation of some heterocyclic bases in the presence of polycrystalline TiO_2 . *Chem Commun*. 2003;(18):2350-2351. doi:10.1039/b306140j.
28. Gambarotti C, Punta C, Recupero F, Caronna T, Palmisano L. TiO_2 in organic photosynthesis: Sunlight induced functionalization of heterocyclic bases. *Curr Org Chem*. 2010;14(11):1153-1169. doi:10.2174/138527210791317111.
29. Fagnoni M, Dondi D, Ravelli D, Albini A. Photocatalysis for the formation of the C-C bond. *Chem Rev*. 2007;107(6):2725-2756. doi:10.1021/cr068352x.
30. Gaya UI, Abdullah AH. Heterogeneous photocatalytic degradation of organic contaminants over titanium dioxide: A review of fundamentals, progress and problems. *J Photochem Photobiol C*. 2008;9(1):1-12. doi:10.1016/j.jphotochemrev.2007.12.003.
31. Hashimoto K, Irie H, Fujishima A. TiO_2 Photocatalysis: A Historical Overview and Future Prospects. *Jpn J Appl Phys*. 2005;44(12):8269-8285. doi:10.1143/JJAP.44.8269.
32. Fujishima A, Zhang X, Tryk DA. TiO_2 photocatalysis and related surface phenomena. *Surf Sci Rep*. 2008;63(12):515-582. doi:10.1016/j.surfrep.2008.10.001.
33. Shah RR, Kaewgun S, Lee BI, Tzeng TRJ. The Antibacterial Effects of Biphasic Brookite-Anatase Titanium Dioxide Nanoparticles on Multiple-Drug-Resistant *Staphylococcus aureus*. *J Biomed Nanotechnol*. 2008;4(3):339-348. doi:10.1166/jbn.2008.324.
34. Miyagi T, Kamei M, Mitsunashi T, Ishigaki T, Yamazaki A. Charge separation at the rutile/anatase interface: a dominant factor of photocatalytic activity. *Chem Phys Lett*. 2004;390(4-6):399-402. doi:10.1016/j.cplett.2004.04.042.
35. Gutierrez C, Salvador P. Mechanisms of Competitive Photoelectrochemical Oxidation of I⁻ and H₂O at n- TiO_2 Electrodes: A Kinetic Approach. *J Electrochem Soc*. 1986;133(5):924-929. doi:10.1149/1.2108764.
36. Salvador P. Influence of pH on the Potential Dependence of the Efficiency of Water Photo-oxidation at n- TiO_2 Electrodes. *J Electrochem Soc*. 1981;128(9):1895-1900. doi:10.1149/1.2127760.
37. Draper RB, Fox MA. Titanium dioxide photosensitized reactions studied by diffuse reflectance flash photolysis in aqueous suspensions of TiO_2 powder. *Langmuir*. 1990;6(8):1396-1402. doi:10.1021/la00098a013.
38. Draper RB, Fox MA. Titanium dioxide photooxidation of thiocyanate: $(\text{SCN})_2^{\cdot-}$ studied by diffuse reflectance flash photolysis. *J Phys Chem*. 1990;94(11):4628-4634. doi:10.1021/j100374a048.
39. Tachikawa T, Tojo S, Fujitsuka M, Majima T. Photocatalytic One-Electron Oxidation of Biphenyl Derivatives Strongly Coupled with the TiO_2 Surface. *Langmuir*. 2004;20(7):2753-2759. doi:10.1021/la0361262.
40. Tachikawa T, Tojo S, Fujitsuka M, Majima T. Influences of Adsorption on TiO_2 Photocatalytic One-Electron Oxidation of Aromatic Sulfides Studied by Time-Resolved Diffuse Reflectance Spectroscopy. *J Phys Chem B*. 2004;108(19):5859-5866. doi:10.1021/jp037003t.
41. Macyk W, Kisch H. Photosensitization of Crystalline and Amorphous Titanium Dioxide by Platinum(IV) Chloride Surface Complexes. *Chemistry*. 2001;7(9):1862-1867. doi:10.1002/1521-3765(20010504)7:9<1862::AID-CHEM1862>3.0.CO;2-G.
42. Fu X, Zeltner WA, Anderson MA. Applications in photocatalytic purification of air. In: Prashant VK, Dan M, eds. *Studies in Surface Science and Catalysis*. Amsterdam: Elsevier, 1997: 445-461.
43. Carp O, Huisman CL, Reller A. Photoinduced reactivity of titanium dioxide. *Prog Solid State Chem*. 2004;32(1-2):33-177. doi:10.1016/j.progsolidstchem.2004.08.001.
44. Matsunaga T, Tomoda R, Nakajima T, Nakamura N, Komine T. Continuous-sterilization system that uses photoconductor powders. *Appl Environ Microbiol*. 1988;54(6):1330-1333.
45. Matsunaga T, Tomoda R, Nakajima T, Wake H. Photoelectrochemical sterilization of microbial cells by semiconductor powders. *FEMS Microbiol Lett*. 1985;29(1-2):211-214. doi:10.1111/j.1574-6968.1985.tb00864.x.
46. Dalrymple OK, Stefanakos E, Trotz MA, Goswami DY. A review of the mechanisms and modeling of photocatalytic disinfection. *Appl Catal B*. 2010;98(1-2):27-38. doi:10.1016/j.apcatb.2010.05.001.
47. Sunada K, Watanabe T, Hashimoto K. Studies on photokilling of bacteria on TiO_2 thin film. *J Photochem Photobiol A*. 2003;156(1-3):227-233. doi:10.1016/S1010-6030(02)00434-3.
48. De Nardo L, Raffaini G, Ganazzoli F, Chiesa R. Metal surface oxidation and surface interactions. In: Williams R, ed. *Surface modification of biomaterials: methods, analysis and applications*. Cambridge, UK: Woodhead Publishing; 2011: 102-142.
49. Cigada A, Cabrini M, Pedferri P. Increasing of the corrosion resistance of the Ti6Al4V alloy by high thickness anodic oxidation. *J Mater Sci Mater Med*. 1992;3(6):408-412. doi:10.1007/BF00701236.
50. Chiesa R, Sandrini E, Santin M, Rondelli G, Cigada A. Osteointegration of titanium and its alloys by anodic spark deposition and other electrochemical techniques: a review. *J*

- Appl Biomater Biomech. 2003;1(2):91-107.
51. Cigada A. Biomaterials, tissue engineering, gene therapy. *J Appl Biomater Biomech*. 2008;6(3):127-131.
 52. Variola F, Brunski JB, Orsini G, Tambasco de Oliveira P, Wazen R, Nanci A. Nanoscale surface modifications of medically relevant metals: state-of-the art and perspectives. *Nanoscale*. 2011;3(2):335-353. doi:10.1039/c0nr00485e.
 53. Choi J-Y, Kim K-H, Choy K-C, Oh K-T, Kim K-N. Photocatalytic antibacterial effect of TiO₂ film formed on Ti and TiAg exposed to *Lactobacillus acidophilus*. *J Biomed Mater Res Part B Appl Biomater*. 2007;80B(2):353-359. doi:10.1002/jbm.b.30604.
 54. Textor M, Sittig C, Frauchiger V, Tosatti S, Brunette DM. Properties and Biological Significance of Natural Oxide Films on Titanium and Its Alloys. In: Brunette DM, Tengvall P, Textor M, Thomsen P, eds. *Titanium in medicine: material science, surface science, engineering, biological responses, and medical applications*. Berlin, New York: Springer; 2001: 171-230.
 55. Brinker CJ, Scherer GW. *Sol-gel science: the physics and chemistry of sol-gel processing*. San Diego: Elsevier Academic Press; 1989.
 56. Alfieri I, Lorenzi A, Montenero A, Gnappi G, Fiori F. Sol-gel silicon alkoxides-polyethylene glycol derived hybrids for drug delivery systems. *J Appl Biomater Biomech*. 2010;8(1):14-19.
 57. Arcos D, Izquierdo-Barba I, Vallet-Regí M. Promising trends of bioceramics in the biomaterials field. *J Mater Sci Mater Med*. 2009;20(2):447-455. doi:10.1007/s10856-008-3616-x.
 58. Nishimura I, Huang Y, Butz F, Ogawa T, Lin A, Wang CJ. Discrete deposition of hydroxyapatite nanoparticles on a titanium implant with predisposing substrate microtopography accelerated osseointegration. *Nanotechnology*. 2007;18(24):245101. doi:10.1088/0957-4484/18/24/245101.
 59. Gupta R, Kumar A. Bioactive materials for biomedical applications using sol-gel technology. *Biomed Mater*. 2008;3(3):034005. doi:10.1088/1748-6041/3/3/034005.
 60. Advincula MC, Rahemtulla FG, Advincula RC, Ada ET, Lemons JE, Bellis SL. Osteoblast adhesion and matrix mineralization on sol-gel-derived titanium oxide. *Biomaterials*. 2006;27(10):2201-2212. doi:10.1016/j.biomaterials.2005.11.014.
 61. Akhavan O. Lasting antibacterial activities of Ag-TiO₂/Ag/a-TiO₂ nanocomposite thin film photocatalysts under solar light irradiation. *J Colloid Interface Sci*. 2009;336(1):117-124. doi:10.1016/j.jcis.2009.03.018.
 62. Akhavan O, Abdolahad M, Abdi Y, Mohajerzadeh S. Synthesis of titania/carbon nanotube heterojunction arrays for photoinactivation of *E. coli* in visible light irradiation. *Carbon*. 2009;47(14):3280-3287. doi:10.1016/j.carbon.2009.07.046.
 63. Ashkarran AA, Aghigh SM, Kaviani-pour M, Farahani NJ. Visible light photo-and bioactivity of Ag/TiO₂ nanocomposite with various silver contents. *Curr Appl Phys*. 2011;11(4):1048-1055. doi:10.1016/j.cap.2011.01.042.
 64. Chun MJ, Shim E, Kho EH, et al. Surface modification of orthodontic wires with photocatalytic titanium oxide for its antiadherent and antibacterial properties. *Angle Orthod*. 2007;77(3):483-488. doi:10.2319/0003-3219(2007)077(0483:SMOOWW)2.0.CO;2.
 65. Daoud WA, Xin JH. Nucleation and growth of anatase crystallites on cotton fabrics at low temperatures. *J Am Ceram Soc*. 2004;87(5):953-955. doi:10.1111/j.1551-2916.2004.00953.x.
 66. Ding XG, Yang H. The physical and antibacterial properties of Argentin-doped TiO₂ film on stainless steel substrate. *Key Eng Mater*. 2005; Vols. 208-283: 801-804.
 67. Gartner M, Trapalis C, Todorova N, et al. Doped sol-gel TiO₂ films for biological applications. *Bull Korean Chem Soc*. 2008;29(5):1038-1042. doi:10.5012/bkcs.2008.29.5.1038.
 68. Gelover S, Gómez LA, Reyes K, Teresa Leal M. A practical demonstration of water disinfection using TiO₂ films and sunlight. *Water Res*. 2006;40(17):3274-3280. doi:10.1016/j.watres.2006.07.006.
 69. Heidenau F, Mittelmeier W, Detsch R, et al. A novel antibacterial titania coating: Metal ion toxicity and in vitro surface colonization. *J Mater Sci Mater Med*. 2005;16(10):883-888. doi:10.1007/s10856-005-4422-3.
 70. Kambala VS, Naidu R. Disinfection Studies on TiO₂ Thin Films Prepared by a Sol-Gel Method. *J Biomed Nanotechnol*. 2009;5(1):121-129. doi:10.1166/jbn.2009.1002.
 71. Marugán J, Christensen P, Egerton T, Purnama H. Synthesis, characterization and activity of photocatalytic sol-gel TiO₂ powders and electrodes. *Appl Catal B*. 2009;89(1-2):273-283. doi:10.1016/j.apcatb.2009.02.007.
 72. Foster HA, Ditta IB, Varghese S, Steele A. Photocatalytic disinfection using titanium dioxide: spectrum and mechanism of antimicrobial activity. *Appl Microbiol Biotechnol*. 2011;90(6):1847-1868. doi:10.1007/s00253-011-3213-7.
 73. Haenle M, Fritsche A, Zietz C, et al. An extended spectrum bactericidal titanium dioxide (TiO₂) coating for metallic implants: in vitro effectiveness against MRSA and mechanical properties. *J Mater Sci Mater Med*. 2011;22(2):381-387. doi:10.1007/s10856-010-4204-4.
 74. Sun CX, Li Q, Gao S, Cao LH, Shang JK. Enhanced Photocatalytic Disinfection of *Escherichia coli* Bacteria by Silver and Nickel Comodification of a Nitrogen-Doped Titanium Oxide Nanoparticle Photocatalyst Under Visible-Light Illumination. *J Am Ceram Soc*. 2010;93(2):531-535. doi:10.1111/j.1551-2916.2009.03388.x.
 75. Yuan WY, Ji J, Fu JH, Shen JC. A facile method to construct hybrid multilayered films as a strong and multifunctional antibacterial coating. *J Biomed Mater Res Part B Appl Biomater*. 2008;85B(2):556-563. doi:10.1002/jbm.b.30979.
 76. Zhao XJ, Zhao QN, Yu JG, Liu BS. Development of multifunctional photoactive self-cleaning glasses. *J Non-Cryst Solids*. 2008;354(12-13):1424-1430. doi:10.1016/j.jnoncrysol.2006.10.093.
 77. Wu P, Xie R, Shang JK. Enhanced Visible-Light Pho-

- tocatalytic Disinfection of Bacterial Spores by Palladium-Modified Nitrogen-Doped Titanium Oxide. *J Am Ceram Soc.* 2008;91(9):2957-2962. doi:10.1111/j.1551-2916.2008.02573.x.
78. Visai L, De Nardo L, Punta C, Melone L, Cigada A, Imbriani M, Arciola CR. Titanium oxide antibacterial surfaces in biomedical devices. *Int J Artif Organs* 2011; 34: 929-946.
79. Delplancke JL, Degrez M, Fontana A, Winand R. Self-colour anodizing of titanium. *Surf Technol.* 1982;16(2):153-162. doi:10.1016/0376-4583(82)90033-4.
80. Delplancke JL, Winand R. Galvanostatic anodization of titanium—II. Reactions efficiencies and electrochemical behaviour model. *Electrochim Acta.* 1988;33(11):1551-1559. doi:10.1016/0013-4686(88)80224-X.
81. Delplancke JL, Winand R. Galvanostatic anodization of titanium—I. Structures and compositions of the anodic films. *Electrochim Acta.* 1988;33(11):1539-1549. doi:10.1016/0013-4686(88)80223-8.
82. Aladjem A. Anodic oxidation of titanium and its alloys. *J Mater Sci.* 1973;8(5):688-704. doi:10.1007/BF00561225.
83. Hurlen T, Gulbrandsen E. Growth of Anodic films on valve metals. *Electrochim Acta.* 1994;39(14):2169-2172. doi:10.1016/S0013-4686(94)85069-0.
84. Yerokhin AL, Nie X, Leyland A, Matthews A, Doney SJ. Plasma electrolysis for surface engineering. *Surf Coat Tech.* 1999;122(2-3):73-93. doi:10.1016/S0257-8972(99)00441-7.
85. Ask M, Lausmaa J, Kasemo B. Preparation and surface spectroscopic characterization of oxide films on Ti6Al4V. *Appl Surf Sci.* 1989;35(3):283-301. doi:10.1016/0169-4332(89)90013-5.
86. Lausmaa J, Kasemo B, Mattsson H, Odelius H. Multi-technique surface characterization of oxide films on electropolished and anodically oxidized titanium. *Appl Surf Sci.* 1990;45(3):189-200. doi:10.1016/0169-4332(90)90002-H.
87. Del Curto B, Brunella MF, Giordano C, et al. Decreased bacterial adhesion to surface-treated titanium. *Int J Artif Organs.* 2005;28(7):718-730.
88. Song W-H, Ryu HS, Hong S-H. Antibacterial properties of Ag (or Pt)-containing calcium phosphate coatings formed by micro-arc oxidation. *J Biomed Mater Res A.* 2009;88A(1):246-254. doi:10.1002/jbm.a.31877.
89. Choi JY, Kim KH, Choy KC, Oh KT, Kim KN. Photocatalytic antibacterial effect of TiO₂ film formed on Ti and TiAg exposed to *Lactobacillus acidophilus*. *J Biomed Mater Res Part B Appl Biomater.* 2007;80B(2):353-359. doi:10.1002/jbm.b.30604.
90. Fröjd V, Linderbäck P, Wennerberg A, Chávez de Paz L, Svensäter G, Davies JR. Effect of nanoporous TiO₂ coating and anodized Ca²⁺ modification of titanium surfaces on early microbial biofilm formation. *BMC Oral Health.* 2011;11(1):8. doi:10.1186/1472-6831-11-8.
91. Iwasaki M, Iwasaki Y, Tada H, Ito S. One-pot process for anodic oxide films of titanium with high photocatalytic activity. *Mater Trans.* 2004;45(5):1607-1612. doi:10.2320/mater-trans.45.1607.
92. Visai L, Rimondini L, Giordano C, et al. Electrochemical surface modification of titanium for implant abutments can affect oral bacteria contamination. *J Appl Biomater Biomech.* 2008;6(3):170-177.
93. Zhitomirsky I. Electrophoretic hydroxyapatite coatings and fibers. *Mater Lett.* 2000;42(4):262-271. doi:10.1016/S0167-577X(99)00197-4.
94. Zhitomirsky I. Cathodic electrodeposition of ceramic and organoceramic materials. Fundamental aspects. *Adv Colloid Interface Sci.* 2002;97(1-3):279-317. doi:10.1016/S0001-8686(01)00068-9.
95. Zhitomirsky I. Electrophoretic deposition of organic-inorganic nanocomposites. *J Mater Sci.* 2006;41(24):8186-8195. doi:10.1007/s10853-006-0994-7.
96. Zhitomirsky I, Gal-Or L. Gal-Or L. Electrophoretic deposition of hydroxyapatite. *J Mater Sci Mater Med.* 1997;8(4):213-219. doi:10.1023/A:1018587623231.
97. Santillán MJ, Quaranta NE, Boccaccini AR. Titania and titania-silver nanocomposite coatings grown by electrophoretic deposition from aqueous suspensions. *Surf Coat Tech.* 2010;205(7):2562-2571. doi:10.1016/j.surfcoat.2010.10.001.
98. Szymanowski H, Sobczykuzenda A, Rylski A, et al. Photo-induced properties of thin TiO₂ films deposited using the radio frequency plasma enhanced chemical vapor deposition method. *Thin Solid Films.* 2007;515(13):5275-5281. doi:10.1016/j.tsf.2006.12.183.
99. Sirghi L, Hatanaka Y. Hydrophilicity of amorphous TiO₂ ultra-thin films. *Surf Sci.* 2003;530(3):L323-L327. doi:10.1016/S0039-6028(03)00397-2.
100. Dumitriu D, Bally AR, Ballif C, et al. Photocatalytic degradation of phenol by TiO₂ thin films prepared by sputtering. *Appl Catal B.* 2000;25(2-3):83-92. doi:10.1016/S0926-3373(99)00123-X.
101. Alexandrov P, Koprinarova J, Todorov D. Dielectric properties of TiO₂-films reactively sputtered from Ti in an RF magnetron. *Vacuum.* 1996;47(11):1333-1336. doi:10.1016/S0042-207X(96)00196-0.
102. Zhang F, Liu X, Jin S, Bender H, Lou NZ, Wilson ZH. Microstructure of titanium oxide films investigated by atomic force microscopy and transmission electron microscopy. *Nucl Instrum Methods Phys Res B.* 1998;142(1-2):61-66. doi:10.1016/S0168-583X(98)00211-0.
103. Miki-Yoshida M. Thin films of photocatalytic TiO₂ and ZnO deposited inside a tubing by spray pyrolysis. *Thin Solid Films.* 2002;419(1-2):60-64. doi:10.1016/S0040-6090(02)00786-1.
104. De Nardo L, Alberti R, Cigada A, Yahia LH, Tanzi MC, Farè S. Shape memory polymer foams for cerebral aneurysm reparation: Effects of plasma sterilization on physical properties and cytocompatibility. *Acta Biomater.* 2009;5(5):1508-1518. doi:10.1016/j.actbio.2008.11.017.
105. De Nardo L, Moscatelli M, Silvi F, Tanzi MC, Yahia LH, Farè S. Chemico-physical modifications induced by plasma and ozone sterilizations on shape memory polyurethane

- foams. *J Mater Sci Mater Med.* 2010;21(7):2067-2078. doi:10.1007/s10856-010-4082-9.
106. De Nardo L, Polizu S, Farè S, Tanzi MC, Yahia LH. Plasma treatment and hydrolysis behaviour of CaloMER™, a shape memory polymer. 7th World Biomaterials Congress 2004: 1116.
107. Rauscher H, Perucca M, Buyle G. Plasma technology for hyperfunctional surfaces: food, biomedical and textile applications. Hoboken, NJ: Wiley-VCH; 2010.
108. Pelletier J, Anders A. Plasma-based ion implantation and deposition: a review of physics, technology, and applications. *IEEE Trans Plasma Sci.* 2005;33(6):1944-1959.
109. Baba K, Hatada R. Synthesis and properties of TiO₂ thin films by plasma source ion implantation. *Surf Coat Tech.* 2001;136(1-3):241-243. doi:10.1016/S0257-8972(00)01022-7.
110. Jing FJ, Wang L, Fu RKY, et al. Behavior of endothelial cells on micro-patterned titanium oxide fabricated by plasma immersion ion implantation and deposition and plasma etching. *Surf Coat Tech.* 2007;201(15):6874-6877. doi:10.1016/j.surfcoat.2006.09.088.
111. Shiraishi K, Koseki H, Tsurumoto T, et al. Antibacterial metal implant with a TiO₂-conferred photocatalytic bactericidal effect against *Staphylococcus aureus*. *Surf Interface Anal.* 2009;41(1):17-22. doi:10.1002/sia.2965.
112. Suketa N, Sawase T, Kitaura H, et al. An antibacterial surface on dental implants, based on the photocatalytic bactericidal effect. *Clin Implant Dent Relat Res.* 2005;7(2):105-111. doi:10.1111/j.1708-8208.2005.tb00053.x.
113. Liu X, Zhao X, Fu RKY, Ho JPY, Ding C, Chu PK. Plasma-treated nanostructured TiO₂ surface supporting biomimetic growth of apatite. *Biomaterials.* 2005;26(31):6143-6150. doi:10.1016/j.biomaterials.2005.04.035.
114. Chu PK. Plasma-Treated Biomaterials. *IEEE Trans Plasma Sci.* 2007;35(2):181-187.
115. Sánchez E, Bannier E, Cantavella V, et al. Deposition of Al₂O₃-TiO₂ Nanostructured Powders by Atmospheric Plasma Spraying. *J Therm Spray Technol.* 2008;17(3):329-337. doi:10.1007/s11666-008-9181-5
116. Li B, Liu X, Meng F, Chang J, Ding C. Preparation and antibacterial properties of plasma sprayed nano-titania/silver coatings. *Mater Chem Phys.* 2009;118(1):99-104. doi:10.1016/j.matchemphys.2009.07.011.
117. Li B, Liu X, Cao C, Ding C. Biocompatibility and antibacterial activity of plasma sprayed titania coating grafting collagen and gentamicin. *J Biomed Mater Res A.* 2007;83A(4):923-930. doi:10.1002/jbm.a.31414.
118. Kikuchi Y, Sunada K, Iyoda T, Hashimoto K, Fujishima A. Photocatalytic bactericidal effect of TiO₂ thin films: dynamic view of the active oxygen species responsible for the effect. *J Photochem Photobiol A.* 1997;106(1-3):51-56. doi:10.1016/S1010-6030(97)00038-5.
119. Kühn KP, Chaberny IF, Massholder K, et al. Disinfection of surfaces by photocatalytic oxidation with titanium dioxide and UVA light. *Chemosphere.* 2003;53(1):71-77. doi:10.1016/S0045-6535(03)00362-X.
120. Yu JC, Ho WK, Lin J, Yip H, Wong PK. Photocatalytic activity, antibacterial effect, and photoinduced hydrophobicity of TiO₂ films coated on a stainless steel substrate. *Environ Sci Technol.* 2003;37(10):2296-2301. doi:10.1021/es0259483.
121. Brook LA, Evans P, Foster HA, et al. Highly bioactive silver and silver/titania composite films grown by chemical vapour deposition. *J Photochem Photobiol A.* 2007;187(1):53-63. doi:10.1016/j.jphotochem.2006.09.014.
122. Yates HM, Brook LA, Ditta IB, et al. Photo-induced self-cleaning and biocidal behaviour of titania and copper oxide multilayers. *J Photochem Photobiol A.* 2008;197(2-3):197-205. doi:10.1016/j.jphotochem.2007.12.023.
123. Matsunaga T. Sterilization with particulate photosemiconductor. *J Antibact Antifung Agents.* 1985;13:211-220.
124. Sunada K, Kikuchi Y, Hashimoto K, Fujishima A. Bactericidal and detoxification effects of TiO₂ thin film photocatalysts. *Environ Sci Technol.* 1998;32(5):726-728. doi:10.1021/es970860o.
125. Yates HM, Brook LA, Sheel DW, Ditta IB, Steele A, Foster HA. The growth of copper oxides on glass by flame assisted chemical vapour deposition. *Thin Solid Films.* 2008;517(2):517-521. doi:10.1016/j.tsf.2008.06.071.
126. Ditta I, Steele A, Liptrot C, et al. Photocatalytic antimicrobial activity of thin surface films of TiO₂, CuO and TiO₂/CuO dual layers on *Escherichia coli* and bacteriophage T4. *Appl Microbiol Biotechnol.* 2008;79(1):127-133. doi:10.1007/s00253-008-1411-8.
127. Paspaltsis I, Kotta K, Lagoudaki R, Grigoriadis N, Poullos I, Sklaviadis T. Titanium dioxide photocatalytic inactivation of prions. *J Gen Virol.* 2006;87(10):3125-3130. doi:10.1099/vir.0.81746-0.
128. van Grieken R, Marugán J, Pablos C, Furones L, López A. Comparison between the photocatalytic inactivation of Gram-positive *E. faecalis* and Gram-negative *E. coli* faecal contamination indicator microorganisms. *Appl Catal B.* 2010;100(1-2):212-220. doi:10.1016/j.apcatb.2010.07.034.
129. Armon R, Laot N, Narkis N, Neeman I. Photocatalytic inactivation of different bacteria and bacteriophages in drinking water at different TiO₂ concentrations with or without exposure to O₂. *J Adv Oxid Technol.* 1998;3:145-150.
130. Araña J, Herrera Melián JA, Doña Rodríguez JM, et al. TiO₂-photocatalysis as a tertiary treatment of naturally treated wastewater. *Catal Today.* 2002;76(2-4):279-289. doi:10.1016/S0920-5861(02)00226-2.
131. Cho M, Choi Y, Park H, Kim K, Woo G-J, Park J. Titanium Dioxide/UV Photocatalytic Disinfection in Fresh Carrots. *J Food Prot.* 2007;70(1):97-101.
132. Saito T, Iwase T, Horie J, Morioka T. Mode of photocatalytic bactericidal action of powdered semiconductor TiO₂ on mutans streptococci. *J Photochem Photobiol B.* 1992;14(4):369-379. doi:10.1016/1011-1344(92)85115-B.

133. Huang Z, Maness P-C, Blake DM, Wolfrum EJ, Smolinski SL, Jacoby WA. Bactericidal mode of titanium dioxide photocatalysis. *J Photochem Photobiol A*. 2000;130(2-3):163-170. doi:10.1016/S1010-6030(99)00205-1.
134. Hu C, Guo J, Qu J, Hu X. Photocatalytic Degradation of Pathogenic Bacteria with AgI/TiO₂ under Visible Light Irradiation. *Langmuir*. 2007;23(9):4982-4987. doi:10.1021/jl063626x.
135. Gogniat G, Thyssen M, Denis M, Pulgarin C, Dukan S. The bactericidal effect of TiO₂ photocatalysis involves adsorption onto catalyst and the loss of membrane integrity. *FEMS Microbiol Lett*. 2006;258(1):18-24. doi:10.1111/j.1574-6968.2006.00190.x.
136. Amézagamadrid P, Silveyramorales R, Córdobaferro L, et al. TEM evidence of ultrastructural alteration on *Pseudomonas aeruginosa* by photocatalytic TiO₂ thin films. *J Photochem Photobiol B*. 2003;70(1):45-50. doi:10.1016/S1011-1344(03)00054-X.
137. Chung C-J, Lin H-I, Chou C-M, et al. Inactivation of *Staphylococcus aureus* and *Escherichia coli* under various light sources on photocatalytic titanium dioxide thin film. *Surf Coat Tech*. 2009;203(8):1081-1085. doi:10.1016/j.surfcoat.2008.09.036.
138. Văcăroiu C, Enache M, Gartner M, et al. The effect of thermal treatment on antibacterial properties of nanostructured TiO₂(N) films illuminated with visible light. *World J Microbiol Biotechnol*. 2009;25(1):27-31. doi:10.1007/s11274-008-9856-6.
139. Erdem A, Metzler D, Chou H. HY L, CP H. Growth and some enzymatic responses of *E.coli* to photocatalytic TiO₂. 2006 NSTI Nanotechnology Conference and Trade Show, 2006: 588-591.
140. Li Y, Ma M, Wang X, Wang X. Inactivated properties of activated carbon-supported TiO₂ nanoparticles for bacteria and kinetic study. *J Environ Sci (China)*. 2008;20(12):1527-1533. doi:10.1016/S1001-0742(08)62561-9.
141. Shah RR, Kaewgun S, Lee BI, Tzeng T-RJ. The Antibacterial Effects of Biphasic Brookite-Anatase Titanium Dioxide Nanoparticles on Multiple-Drug-Resistant *Staphylococcus aureus*. *J Biomed Nanotechnol*. 2008;4(3):339-348. doi:10.1166/jbn.2008.324.
142. Gartner M, Anastasescu C, Zaharescu M, et al. The Simulation in the Real Conditions of Antibacterial Activity of TiO₂ (Fe) Films with Optimized Morphology. In: Mathur S, Singh M, eds. *Nanostructured Materials and Nanotechnology II: Ceramic Engineering and Science Proceedings*, Volume 29, Issue 8. Hoboken, NJ: John Wiley & Sons; 2009: 67-76. doi: 10.1002/9780470456248.ch6
143. Miron C, Roca A, Hoisie S, Cozorici P, Sirghi L. Photoinduced bactericidal activity of TiO₂ films obtained by radio-frequency magnetron sputtering deposition. *Optoelectron Adv Mater*. 2005;7(2):915-919.
144. Suwalsky M, Schneider C, Mansilla HD, Kiwi J. Evidence for the hydration effect at the semiconductor phospholipid-bilayer interface by TiO₂ photocatalysis. *J Photochem Photobiol B*. 2005;78(3):253-258. doi:10.1016/j.jphotochem.2004.11.016.
145. Nadtochenko V, Denisov N, Sarkisov O, Gumy D, Pulgarin C, Kiwi J. Laser kinetic spectroscopy of the interfacial charge transfer between membrane cell walls of *E. coli* and TiO₂. *J Photochem Photobiol A*. 2006;181(2-3):401-407. doi:10.1016/j.jphotochem.2005.12.028.
146. Nadtochenko V, Sarkisov O, Nikandrov V, Chubukov P, Denisov N. Inactivation of pathogenic microorganisms in the photocatalytic process on nanosized TiO₂ crystals. *Russ J Phys Chem B*. 2008;2(1):105-114.
147. Nadtochenko VA, Rincon AG, Stanca SE, Kiwi J. Dynamics of *E. coli* membrane cell peroxidation during TiO₂ photocatalysis studied by ATR-FTIR spectroscopy and AFM microscopy. *J Photochem Photobiol A*. 2005;169(2):131-137. doi:10.1016/j.jphotochem.2004.06.011.
148. Ireland JC, Klostermann P, Rice EW, Clark RM. Inactivation of *Escherichia coli* by titanium dioxide photocatalytic oxidation. *Appl Environ Microbiol*. 1993;59(5):1668-1670.
149. Maness P-C, Smolinski S, Blake DM, Huang Z, Wolfrum EJ, Jacoby WA. Bactericidal Activity of Photocatalytic TiO₂ Reaction: toward an Understanding of Its Killing Mechanism. *Appl Environ Microbiol*. 1999;65(9):4094-4098.
150. Salih FM. Enhancement of solar inactivation of *Escherichia coli* by titanium dioxide photocatalytic oxidation. *J Appl Microbiol*. 2002;92(5):920-926. doi:10.1046/j.1365-2672.2002.01601.x.
151. Cho M, Chung H, Choi W, Yoon J. Linear correlation between inactivation of *E. coli* and OH radical concentration in TiO₂ photocatalytic disinfection. *Water Res*. 2004;38(4):1069-1077. doi:10.1016/j.watres.2003.10.029.
152. Cho M, Chung H, Choi W, Yoon J. Different Inactivation Behaviors of MS-2 Phage and *Escherichia coli* in TiO₂ Photocatalytic Disinfection. *Appl Environ Microbiol*. 2005;71(1):270-275. doi:10.1128/AEM.71.1.270-275.2005.
153. Visai L, Arciola CR, Pietrocola G, Rindi S, Olivero P, Speziale P. *Staphylococcus* biofilm components as targets for vaccines and drugs. *Int J Artif Organs*. 2007;30(9):813-819.
154. Giordano C, Saino E, Rimondini L, et al. Electrochemically induced anatase inhibits bacterial colonization on Titanium Grade 2 and Ti6Al4V alloy for dental and orthopedic devices. *Colloids Surf B Biointerfaces*. 2011;88(2):648-655. doi:10.1016/j.colsurfb.2011.07.054.
155. Dunlop PSM, Sheeran CP, Byrne JA, McMahon MAS, Boyle MA, McGuigan KG. Inactivation of clinically relevant pathogens by photocatalytic coatings. *J Photochem Photobiol A*. 2010;216(2-3):303-310. doi:10.1016/j.jphotochem.2010.07.004.
156. Gage JP, Roberts TM, Duffy JE. Susceptibility of *Pseudomonas aeruginosa* biofilm to UV-A illumination over photocatalytic and non-photocatalytic surfaces. *Biofilms*. 2005;2(03):155-163. doi:10.1017/S1479050505001857.
157. Liu Y, Li J, Qiu X, Burda C. Bactericidal activity of nitro-

- gen-doped metal oxide nanocatalysts and the influence of bacterial extracellular polymeric substances (EPS). *J Photochem Photobiol A*. 2007;190(1):94-100. doi:10.1016/j.jphotochem.2007.03.017.
158. Blackwood DJ. Biomaterials: Past successes and future problems. *Corros Rev*. 2003;21(2-3):97-124. doi:10.1515/CORRREV.2003.21.2-3.97.
159. Brunski JB. Metals. In: Ratner BD, Schoen FJ, Lemons JE, eds. *Biomaterials Science: An Introduction to Materials in Medicine*. Amsterdam: Elsevier Academic Press; 1996: 37-50.
160. Freese HL, Volas MG, Wood JR. Metallurgy and technological properties of Titanium and Titanium alloys. In: Brunette DM, Tengvall P, Textor M, Thomsen P, eds. *Titanium in medicine: material science, surface science, engineering, biological responses, and medical applications*. Berlin, New York: Springer; 2001: 25-51.
161. Navarro M, Michiardi A, Castaño O, Planell JA. Biomaterials in orthopaedics. *J R Soc Interface*. 2008;5(27):1137-1158. doi:10.1098/rsif.2008.0151.
162. Niinomi M. Metallic biomaterials. *J Artif Organs*. 2008;11(3):105-110. doi:10.1007/s10047-008-0422-7.
163. Zaleska A. Doped-TiO₂: A review. *Recent Pat Biomed Eng*. 2008;2(3):157-164. doi:10.2174/187221208786306289.